

FPCCD digitizer and reconstruction

Daisuke Kamai Tohoku university

Y.Takubo Y.Sugimoto A.Miyamoto (KEK)
K.Yoshida H.Yamamoto (Tohoku)

FPCCD vertex detector

FPCCD vertex detector

■ FPCCD(Fine Pixel CCD)

- Pixel size : $5\mu\text{m} \times 5\mu\text{m}$
- Sensitive thickness : $15\mu\text{m}$
- The number of pixels : $\sim 10^{10}$ pixels
- Fully depleted sensor
- Read out time : Inter-train

Beam structure

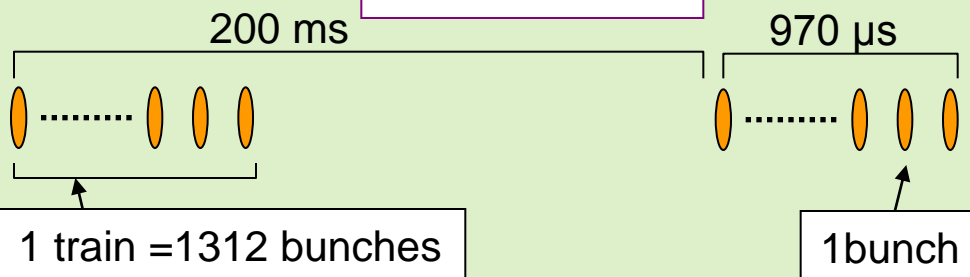

FPCCD vertex detector

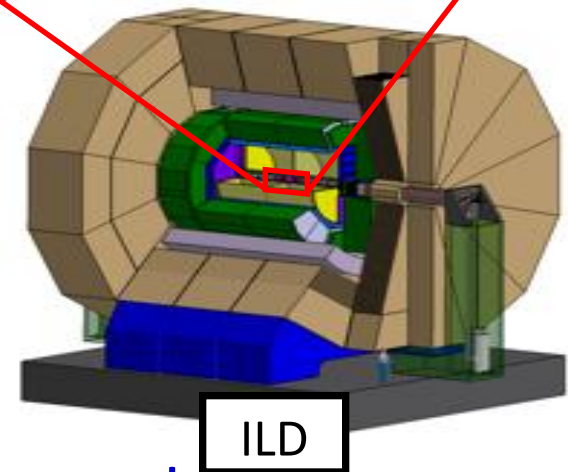
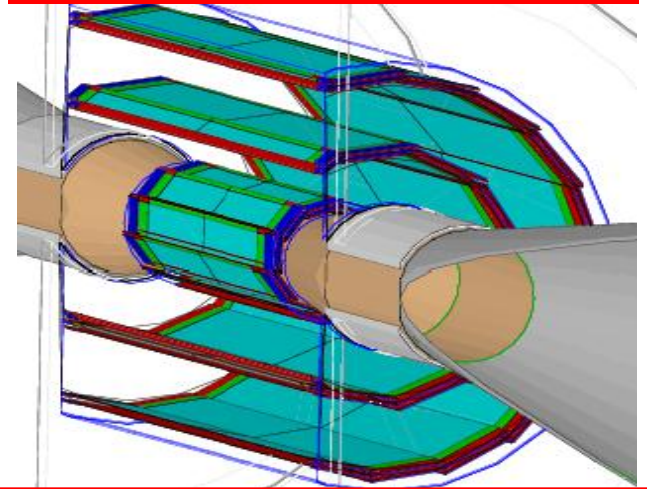

By using FPCCD, many advantages are expected.

Advantage of FPCCD

- **High spatial resolution** because of very small pixel size.
→ **High impact parameter resolution** is also expected.
- **High two-track separation capability** because of fully depleted sensor.
- **Low pixel occupancy** because of a large number of pixels.
- **Not affected by RF noise** produced by the beam because the signal is read out in the interval between train and train.
- Background rejection by using the cluster shapes.

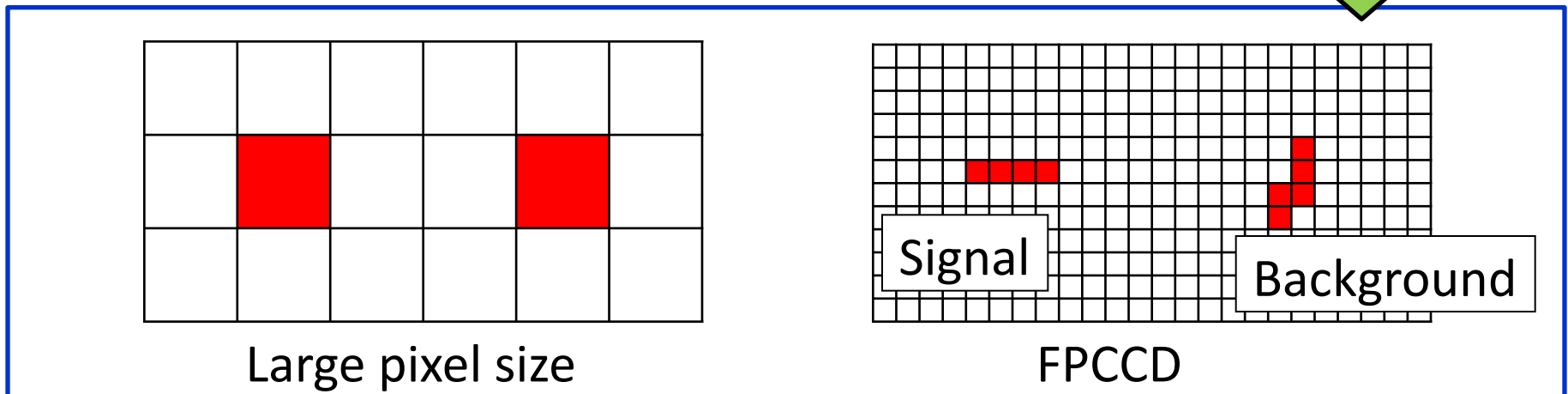

Software for FPCCD vertex detector

Purpose

- Evaluation of the tracking and vertexing performance.
- Evaluation of the background effect.
- Estimation of the flavor tagging and charge ID performance.

→ For this purpose, software for FPCCD vertex detector was developed.

- FPCCD digitizer (generate signals)
- Overlay processor (merge background into physics event)
- FPCCD clustering (reconstruct the hit point from pixel hits)

These software operate as a part of MarlinReco package.



Simulation study of FPCCD under background is available.

Simulation study of FPCCD vertex detector

The performance of FPCCD vertex detector was checked by using the software for FPCCD vertex detector.

Today's talk

- Range cut.
- The spatial resolution and the impact parameter resolution.
- The pixel occupancy of pair background.
- The flavor tagging.

Range cut

■ Range cut

- The limit of track length in Geant simulation.
- Shorter range cut is accurate, but time consuming.
- Default value : 100um > 5um (FPCCD pixel size)

The determination of the short enough “range cut” value for FPCCD simulation study is required.

■ The analysis of pair background samples with various range cut are being performed.

- Range cut : 1, 2, 5, 10, 20, 100 um
- There are no conclusions yet.

In this talk, the range cut of all results are set to 100um.

Spatial resolution

- The θ dependency of the spatial resolution was checked.
 - μ^- (Momentum 100GeV)
 - σ_{noise} : 50 electrons /pixel.
 - Threshold : 200 electrons /pixel.

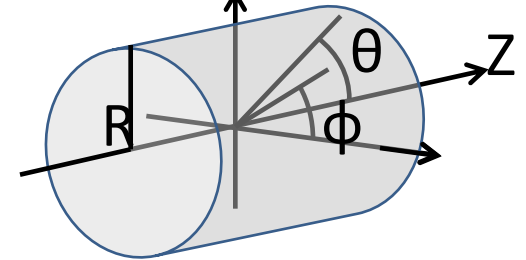

θ	σ_z	$\sigma_{R-\phi}$
90°	1.5 μm	0.94 μm
75°	0.64 μm	0.96 μm
60°	0.83 μm	0.96 μm
45°	1.2 μm	0.96 μm
30°	1.6 μm	0.98 μm
LOI value	2.8 μm	2.8 μm

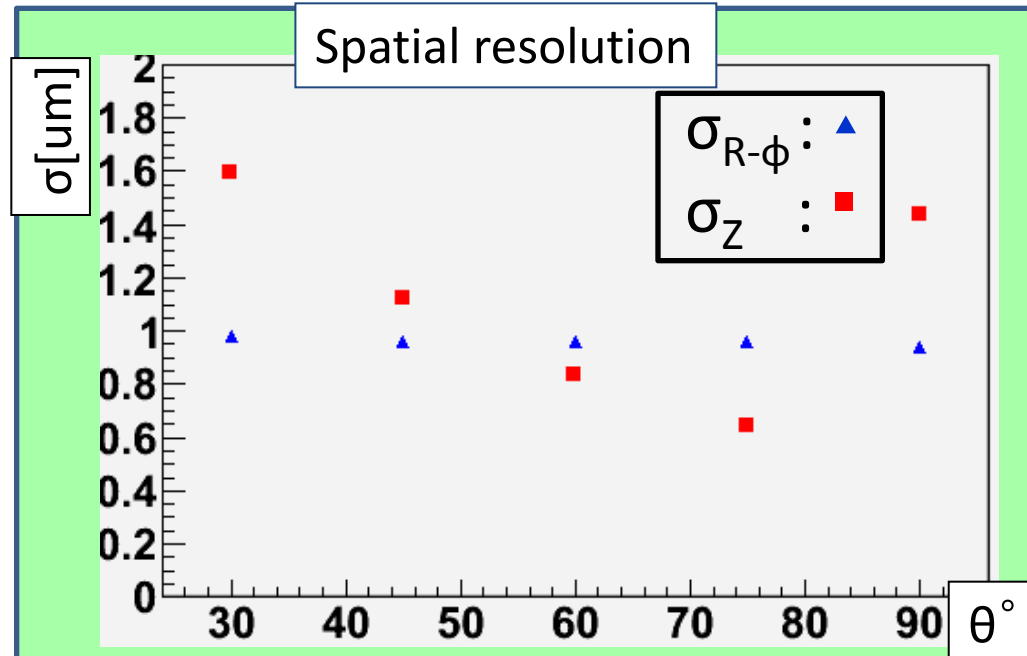

- The Z resolution is worse at forward.
- The R- ϕ resolution does not depends on θ .
- The Z resolution of the vertical track is bad.

Impact parameter resolution

- The θ dependency of the impact parameter resolution was checked.
 - μ^- (Momentum 100GeV)
 - σ_{noise} : 50 electrons /pixel
 - Threshold : 200 electrons /pixel.

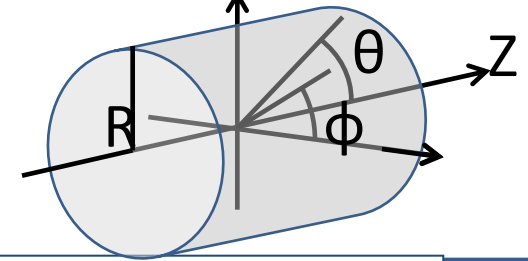

θ	σ_{R-Z}	$\sigma_{R-\phi}$
90°	1.7 μm	1.2 μm
75°	1.5 μm	1.2 μm
60°	2.9 μm	1.1 μm
45°	3.4 μm	1.1 μm
30°	4.3 μm	1.2 μm
LOI value	—	2.0 μm

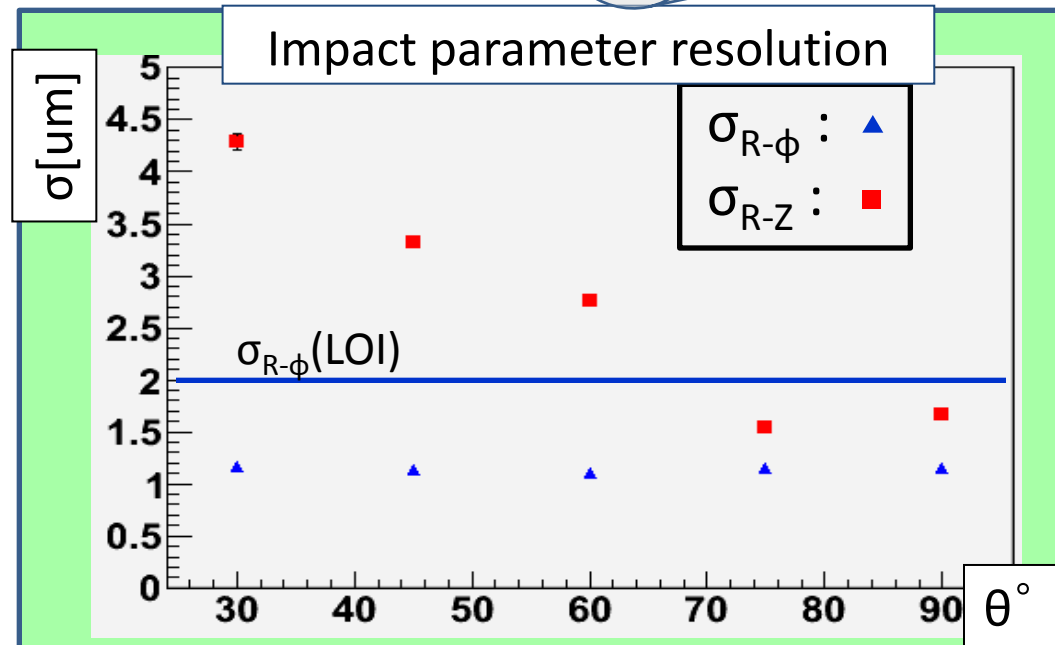

- The impact parameter resolution is roughly proportional to the spatial resolution.
- Spatial resolution and IP resolution are better than LOI value.

Pair background occupancy

- The pixel occupancy of the FPCCD VTX **innermost, second layer** was checked.

Background conditions

- Generator : Guinea Pig
- Beam parameter :
SB2009w/TF
- CM energy : 500 GeV
- Range cut : 100 μm

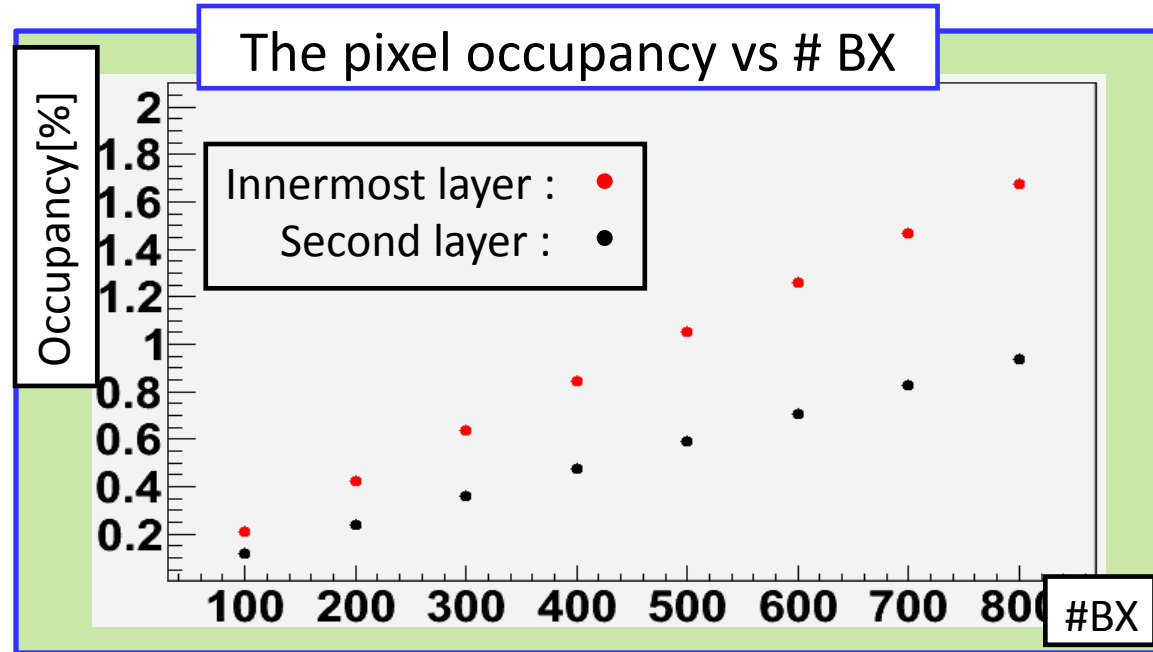

Pixel occupancy for 1train(1312 BX)

- Innermost layer : **2.76%**
- Second layer : **1.55%**

Very low occupancy, compared with conventional CCD.
(25 μm pixel > 10%)

Flavor tagging

- Estimation of the flavor tagging performance was started.
 - $e^+e^- \rightarrow b\bar{b}$, $e^+e^- \rightarrow c\bar{c}$ event
 - CM energy : 91 GeV
 - 1000 events

Flavor tagging for Zpole events

$ee \rightarrow bb$ — blue line
 $ee \rightarrow cc$ — red line

b-tag

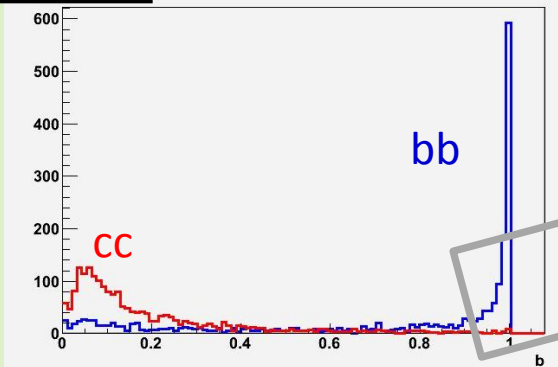

c-tag

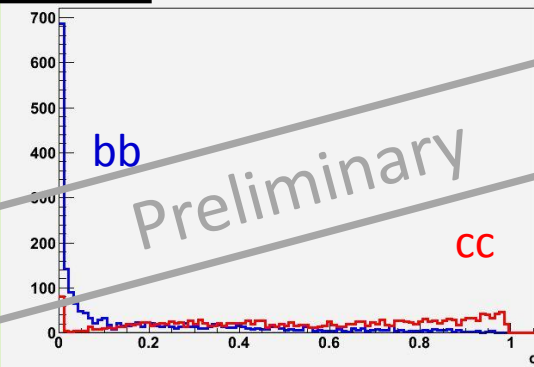

bc-tag

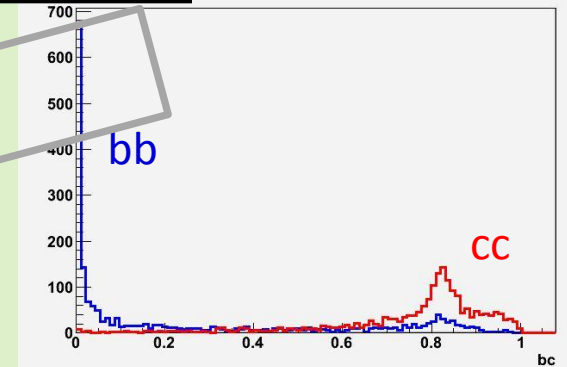

Preliminary

- Efficiency and purity will be checked.

Summary

- FPCCD software were developed.
 - Simulation study of FPCCD under background is available.

The result of simulation study of FPCCD vertex detector

- Spatial resolution
 - $\sigma_{R-\phi} = \sim 0.96 \text{ um}$
 - $\sigma_z = 0.64 \text{ um} (\theta = 75^\circ)$
- IP resolution
 - $\sigma_{R-\phi} = \sim 1.2 \text{ um}$
 - $\sigma_{R-Z} = 1.5 \text{ um} (\theta = 75^\circ)$

These values were better than LOI.

- Pixel occupancy of pair background for 1train(1312BX)
 - Innermost layer : 2.76%
 - second layer : 1.55%

FPCCD realizes low occupancy, compared with conventional CCD.
- Flavor tagging study was started.
 - Efficiency and purity will be checked.

Plan

- Determination of short enough range cut for FPCCD.
- Estimation of the flavor tagging and charge ID performance.
- Development of FPCCD track finder.
 - Using information of the cluster shapes.

Back up

FPCCD digitizer

- The hit points and track momenta are obtained from true hit.
- The track is calculated by the hit point and momentum.
- The pixel hit is identified by the intersections of track and boundaries of pixels.

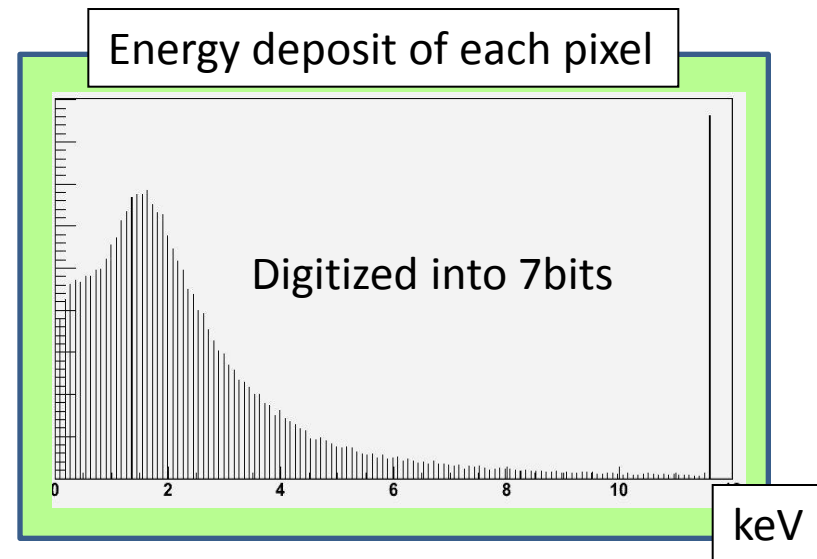
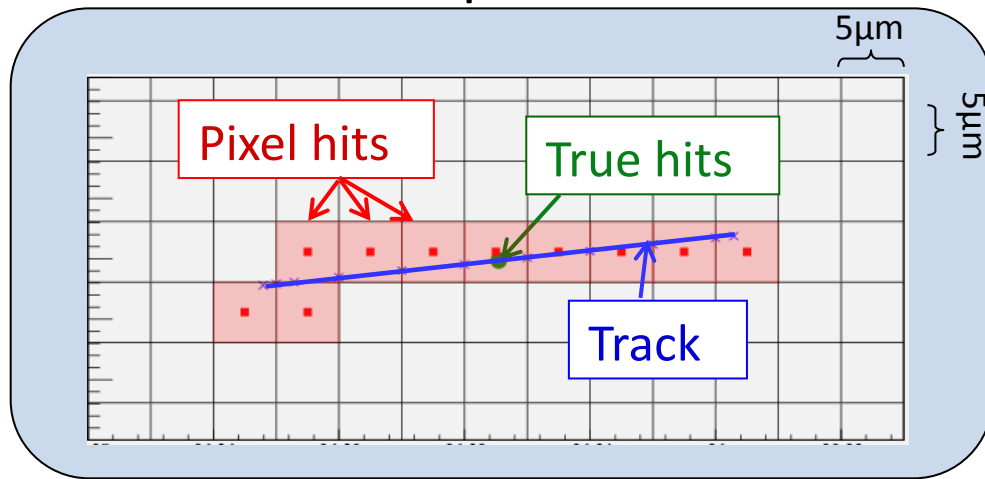

- The energy deposit of true hits is divided into pixels as proportional to path length and these are approximated by Landau distribution.
- The noise is put on to each pixel hit.

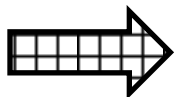

The output is the position of pixel hit and its energy deposit.

Output collection from FPCCD digitizer

Format of LCGenericObject

- The first word(32 bits) contains layer number and ladder number of the element.

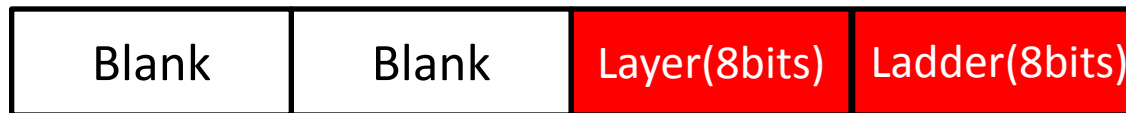

- Two words are used for each pixel hit.

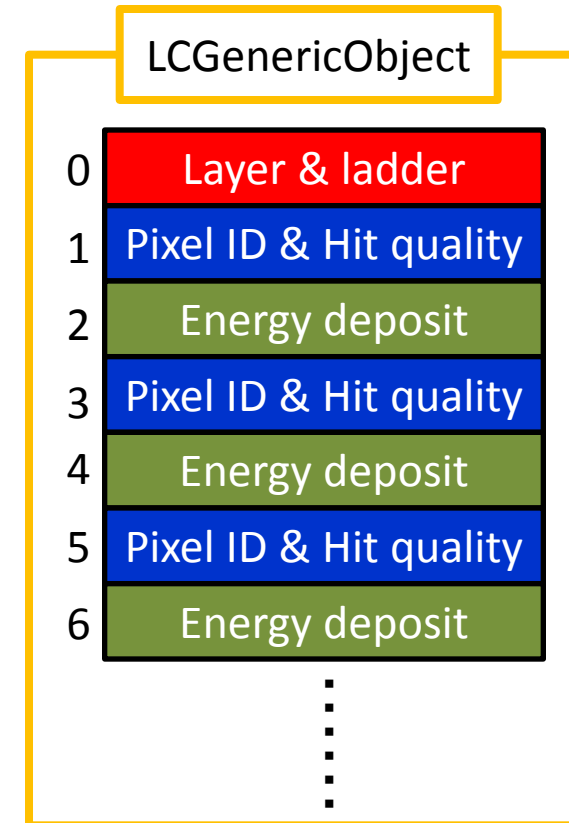
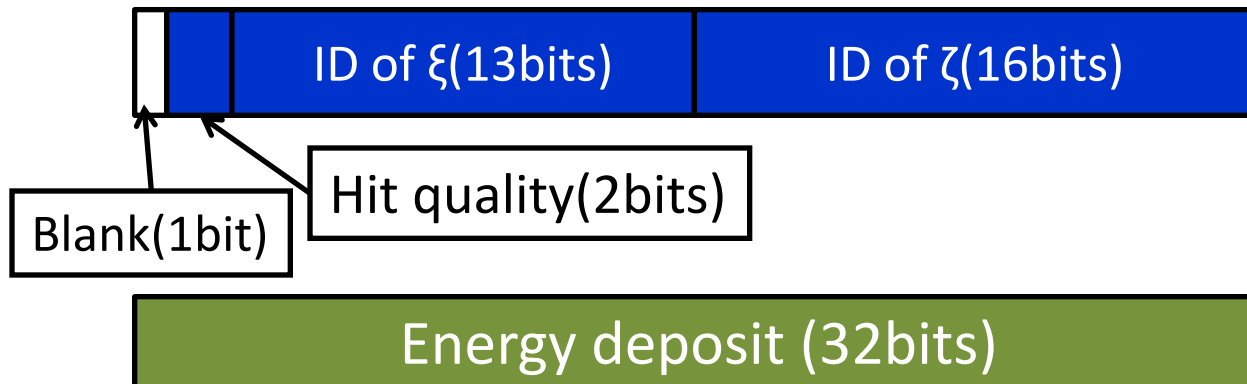

- The number of elements is equal to that of the ladders with hits.
- Data size for one element : $(2 \times N_{\text{hits}} + 1)$ words
 - The blank area is reserved for the future use.

Overlay processor

- Overlay processor merges the data of background into the data of signal.
- If there are more than 2 hits in the same pixel, the processor adds the energy deposit of both hits.

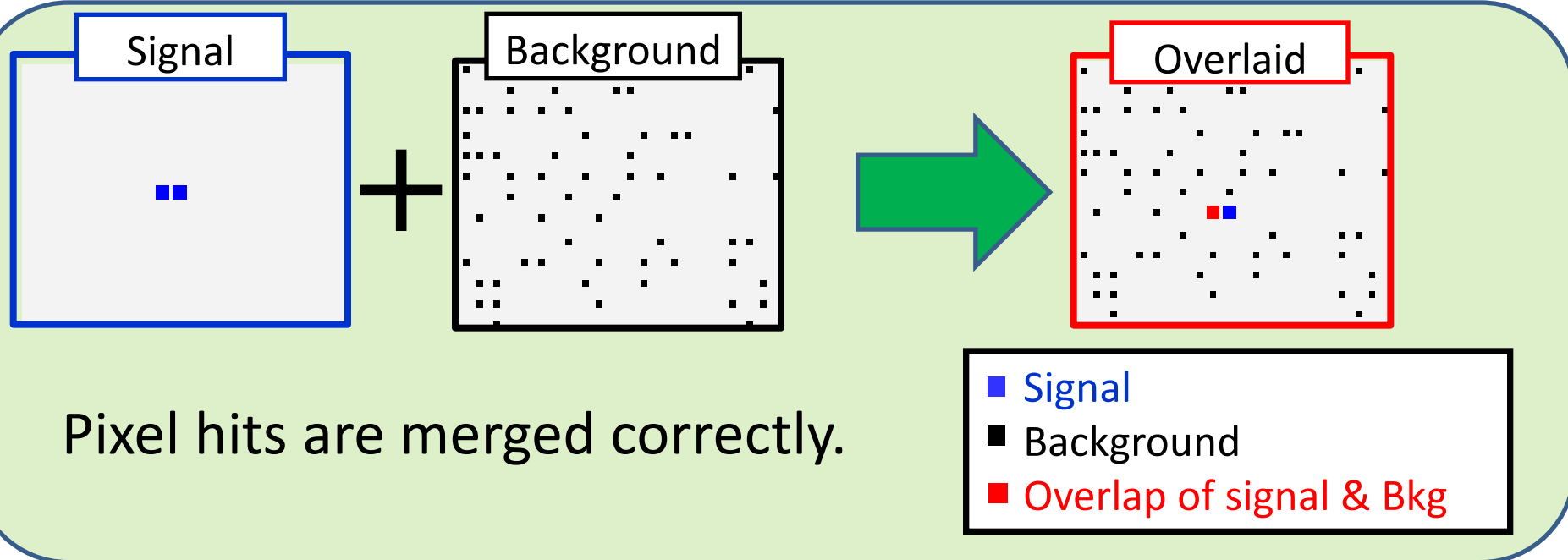

Simulation study under background is available.

FPCCD clustering

- The position of pixel hit and its energy deposit is obtained from FPCCD digitizer.
- The neighboring pixels are recognized as a cluster.
- The hit point is reconstructed as an energy weighted position.

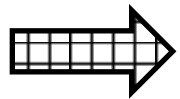

The output is TrackerHit collection.

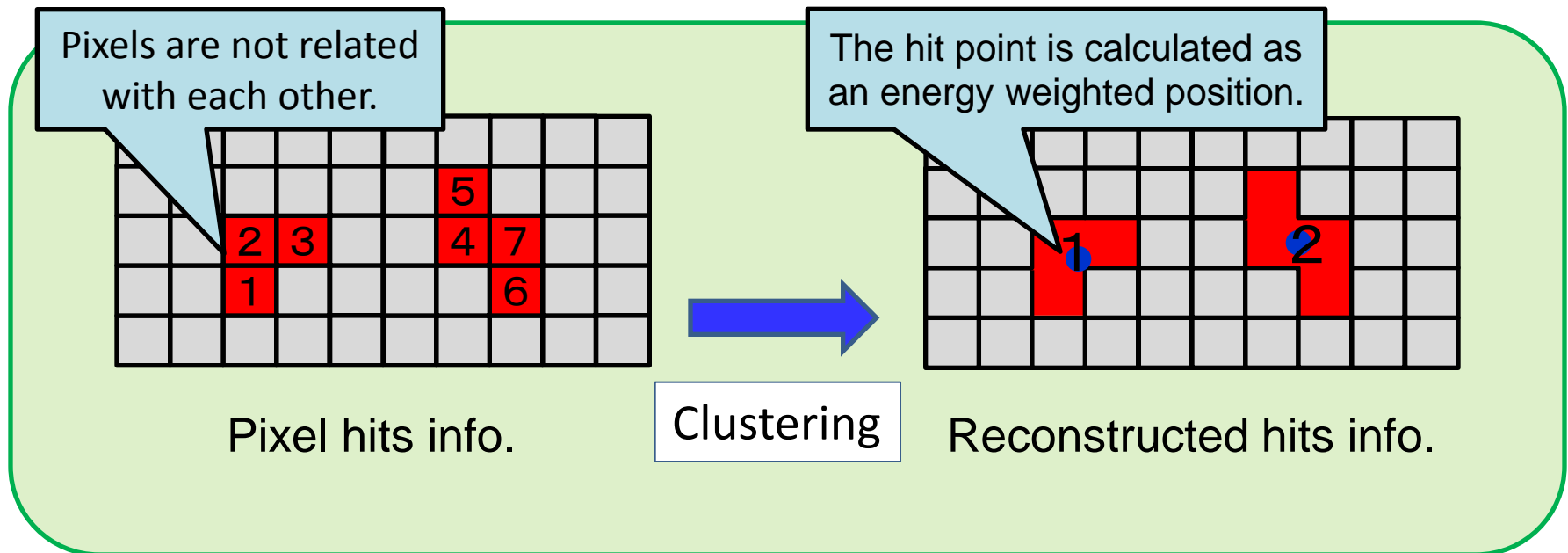

Background rejection algorithm

The cluster width in Z direction

- The cluster width of signal is depends on Z.

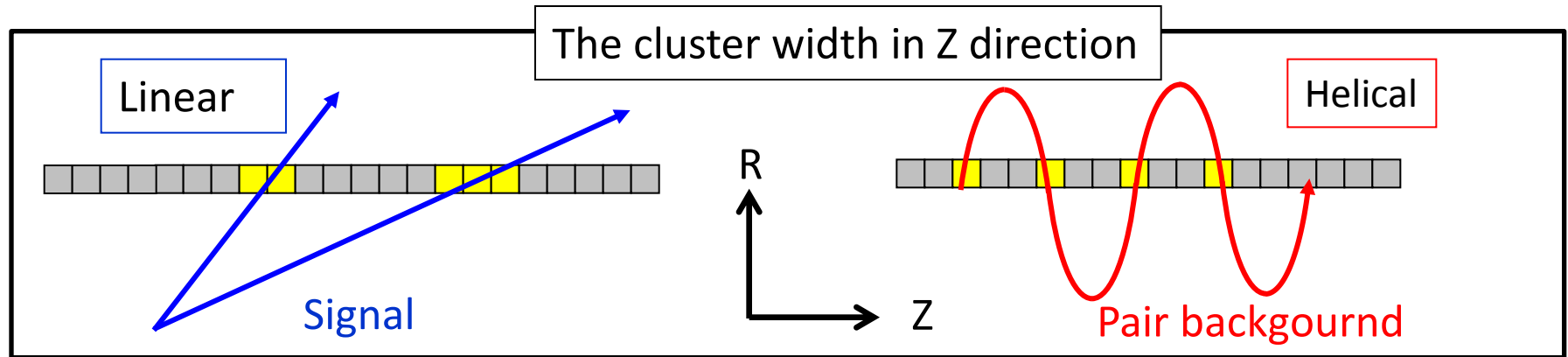

The cluster width in ϕ direction

- Signal hits a few pixels.

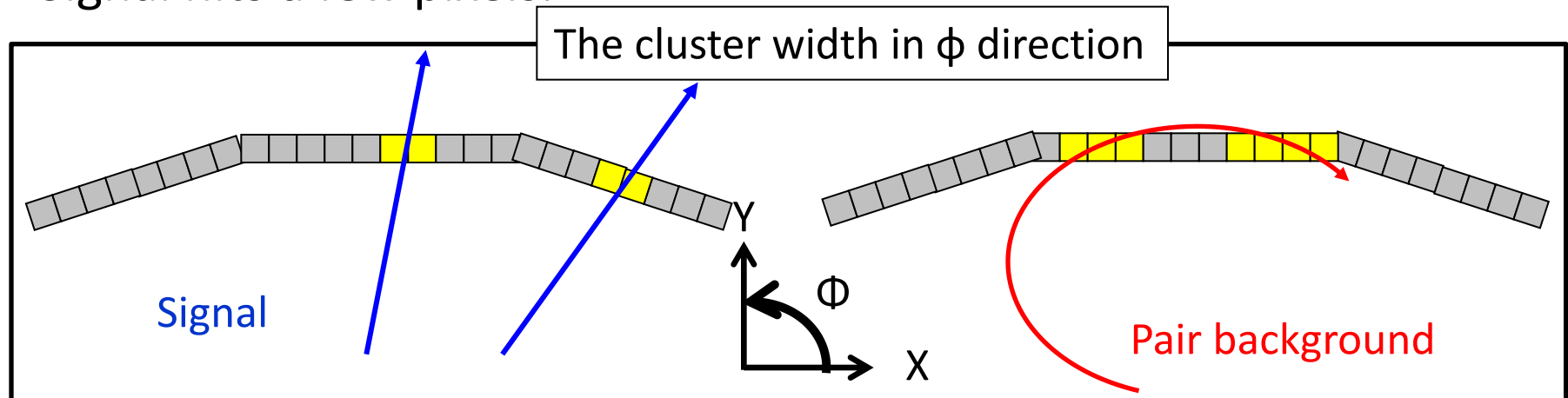

Cluster width cut

- The inside of **green line** was accepted.

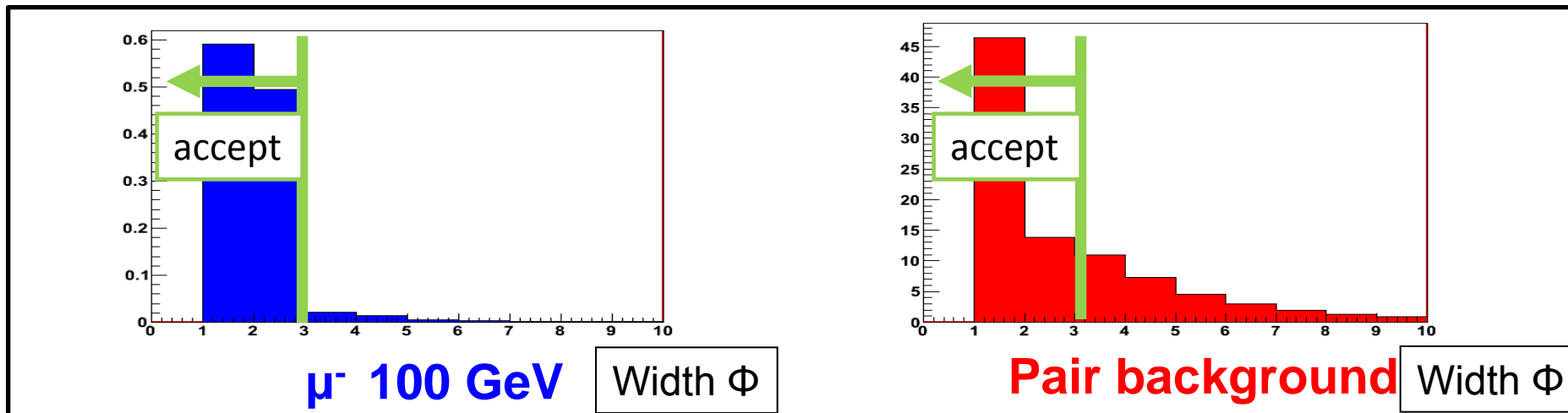
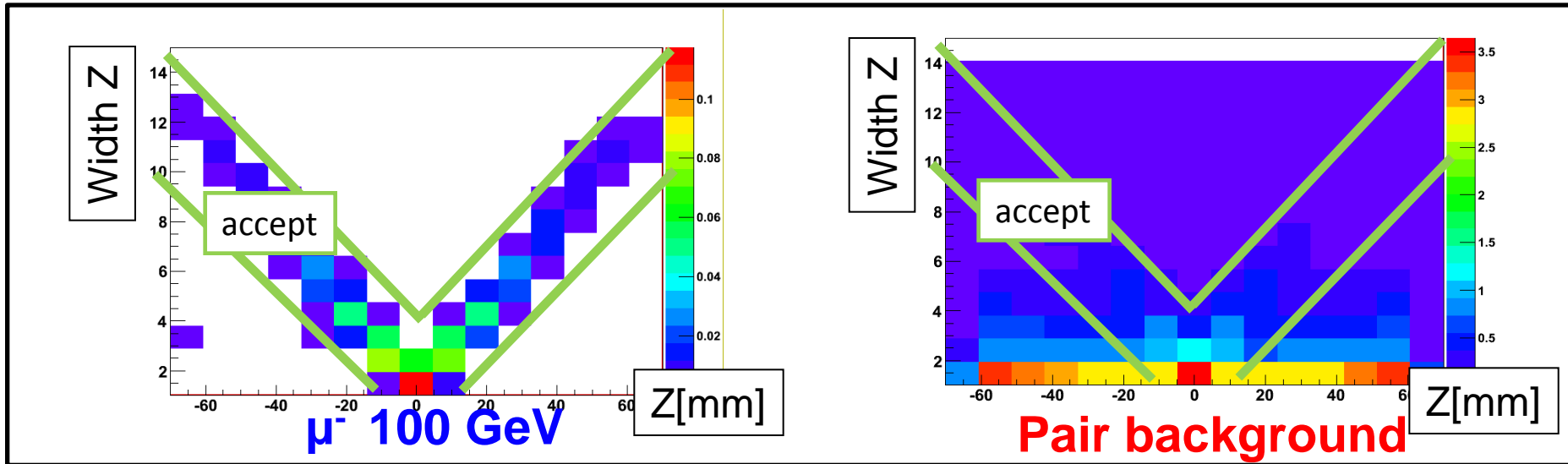

Cut efficiency

- The μ -(Momentum 100GeV) hits and pair background hits were separated by using the cluster shapes.

Efficiency

	innermost	second
μ -(Momentum 100GeV)	99.2%	99.7%
Pair background	8.53%	9.37%

- The background hits decreased to 1/10, keeping 99% μ -efficiency.
- The challenge is to increase the efficiency of low-energy signals keeping background hits low.

Sensor R&D (0)

- Development of fully depleted CCD
 - Indispensable for FPCCD R&D
 - Base: Back-illuminating CCD with 24um pixels
 - Epitaxial layer with higher resistivity
 - Full depletion has been confirmed by observing signal spread for line-focused LASER

