

R&D status of FPCCD vertex detector

2013 11/12 LCWS@ University of Tokyo .

Ito Shuhei(Tohoku Univ.)

D.Abhinav ,C.Constantino, H.Ikeda, A.Ishikawa E.Kato, A.Miyamoto,
T.Mori, N.Shinoda, H.Sato, T.Suehara, Y.Sugimoto, H.Yamamoto, Y.Yasu,
S.Yamaguti, I.Ushiki

contents

1. Purpose of Vertex Detector
2. FPCCD Vertex Detector
3. R&D status
4. Damage from neutron
5. Characteristics of FPCCD
6. Read out modules
7. Characteristics before irradiation
 - Hot pixel
 - CTI
 - Dark current
8. Neutron Irradiation
 - set up
 - flux of neutron
9. Result of irradiation
 - hot pixel
 - CTI
- 10 . Summary & plan

Purpose of Vertex Detector

Major targets of ILC are...

- precise measurement of Higgs
- precise measurement of Top quark
- Search for beyond the standard model

Higgs particles dominantly tend to decay bb , cc , gg .

To measure those BR, we need to identify b c g precisely

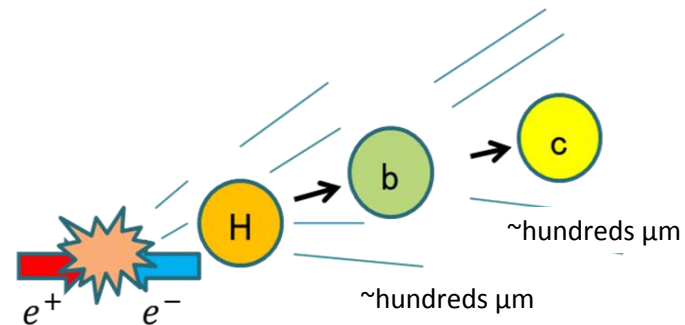
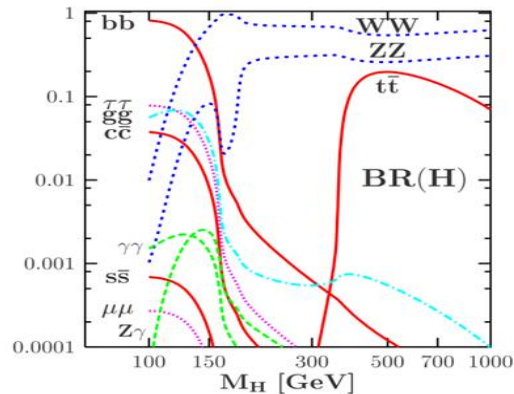

To tag b , c and g from vertex position, we require less than $3\mu\text{m}$ resolution for vertex detector

FPCCD Vertex Detector

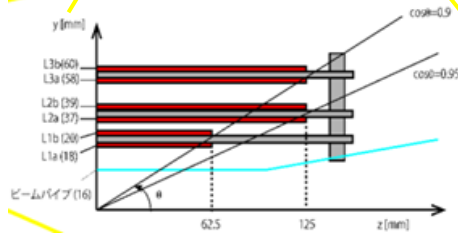
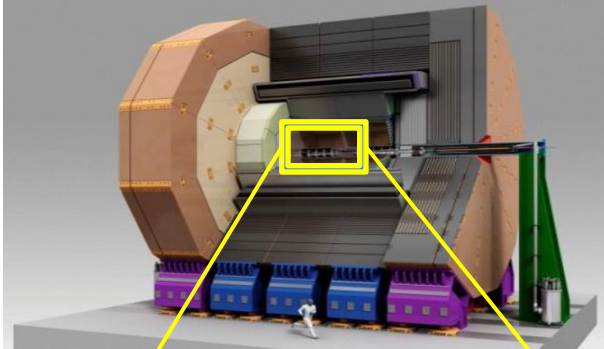

Merit of FPCCD

- 😊 Position resolution is very good ($\sim 1\mu\text{m}$)
- 😊 Pixel occupancy is low
 - so many pixels
- 😊 signal is less affected by electromagnetic interference
 - inter-train read-out
- 😊 smaller gain fluctuation
 - amplify each signal after transferring

FPCCD : Fine Pixel Charge Coupled Device

Vertex detector

- Most inner layer located 16mm from the IP
 - to achieve high impact parameter resolution
- Thin sensor and support structure
 - to reduce multiple scattering ,
- Three doublet-layer structure
 - Better pattern recognition not to associate BG hits

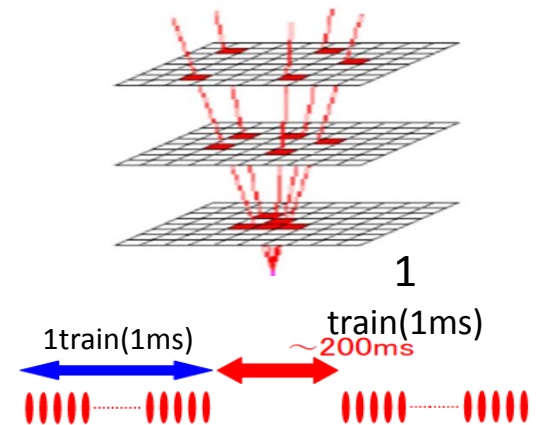

R&D status

FPCCD's Goal

pixel size : $5 \times 5 \mu\text{m}^2$
Sensitive thickness : $15 \mu\text{m}$
Total thickness : $50 \mu\text{m}$

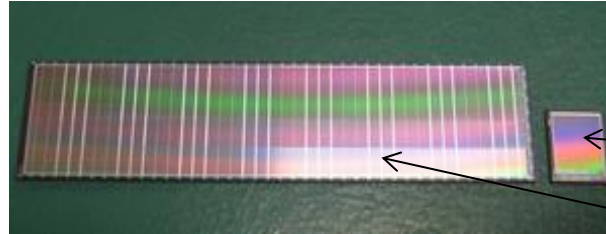

6 μm pixel small prototype sensors
Working properly

Small prototype

Large prototype

Read out circuits 's Goal

- i) read-out speed $> 10 \text{Mpixels} / \text{s}$ (100MHz)
 - to read out all pixel in 200ms (inter -train)
- ii) noise of read-out circuits < 30 electrons
 - small number of electron-hole pair produced when particles incident at shallow angle
- iii) consumed power $< 6 \text{mW} / \text{ch}$
 - to keep temperature -40°C

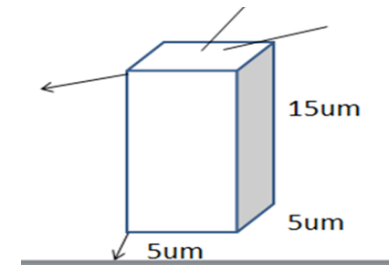
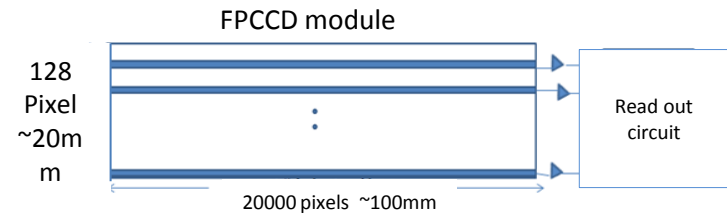

recent prototype
read out circuit

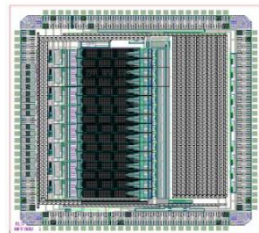

Read-out speed : $12 \text{Mpixel} / \text{s}$
Noise : 48 electrons
Power consumption: $5.8 \text{mW} / \text{ch}$

Read-out speed
Power consumption
OK!

Bulk damage

High energy electron and Heavy particles like neutron sometimes make lattice defect in FPCCD. Charge signals are often trapped by lattice defect then signal will reduce...

Lattice defect

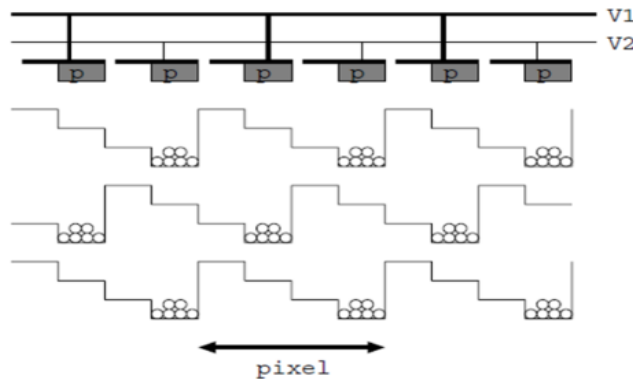
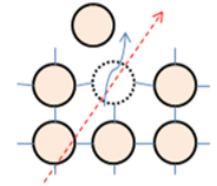

CCD transfers charge signal like bucket-brigade.

- FPCCD has so many pixels

then few lattice defect can effect on transfer

neutron equivalent flux of $O(10^{10})$ neutrons/cm² incident upon the vertex detector may degrade its performance

According to simulation result, neutron come from mainly beam dump.

And neutron fluence was determined to be 1.85×10^9 neutron/cm²/year.

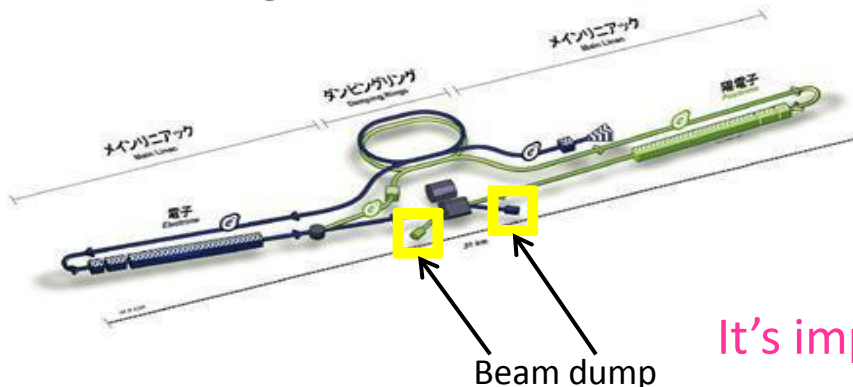

It's important to measure tolerance of detector!

Characteristics of FPCCD

i) CTI(Charge Transfer Inefficiency)

Inefficiency in transferring charge to neighboring pixel
we test CTI using X-ray from Fe55.

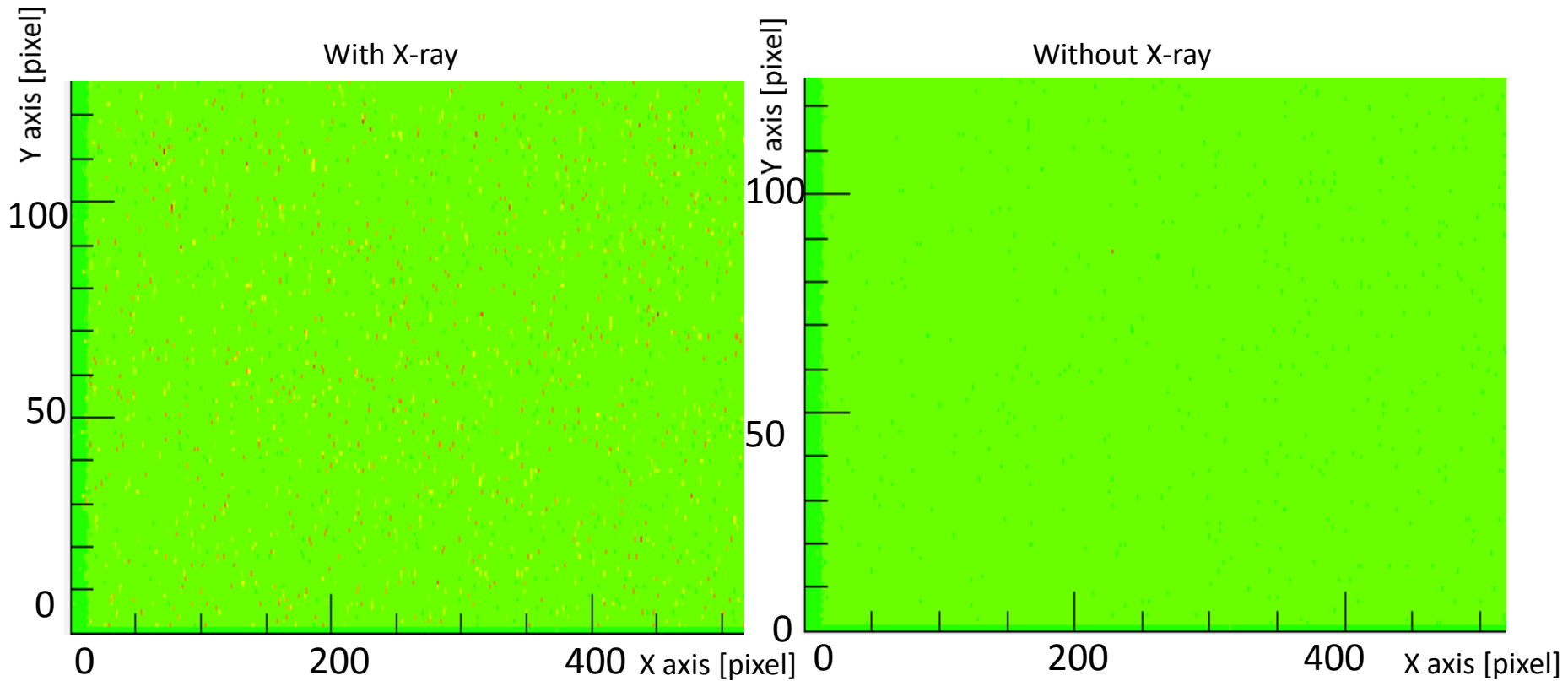

Characteristics of FPCCD

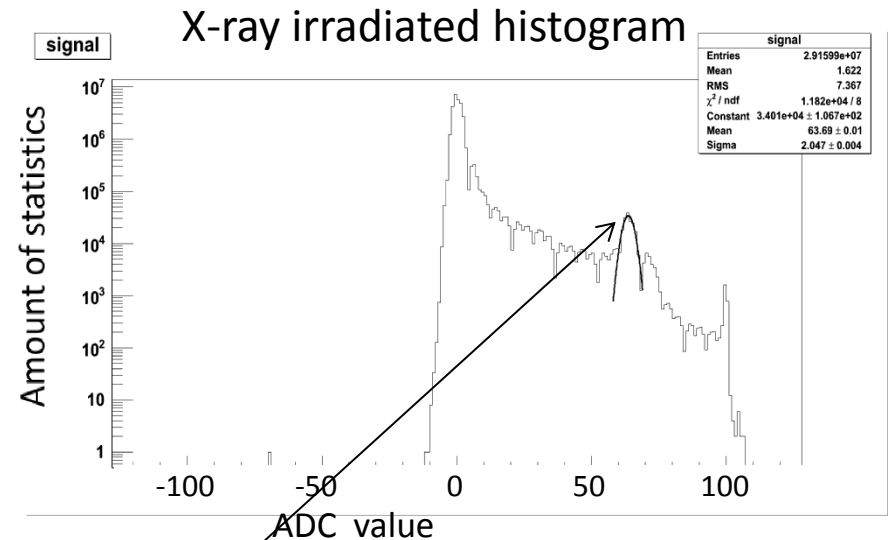
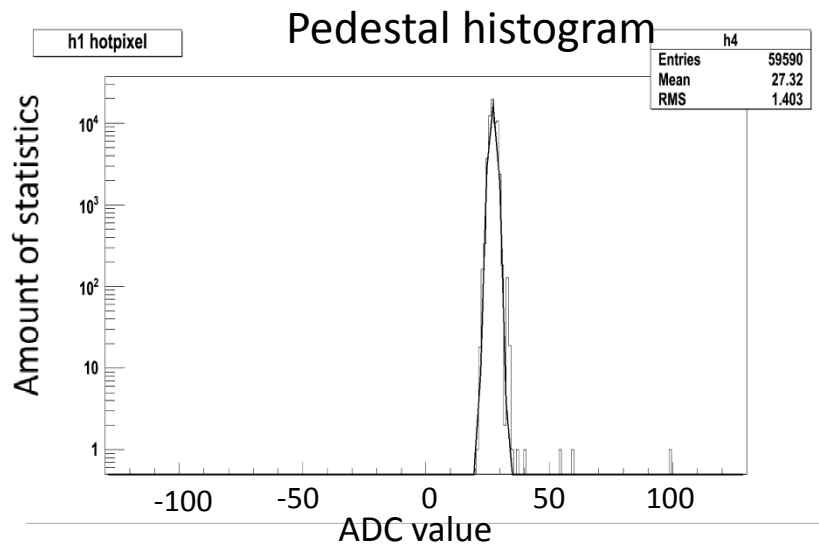

Fe55 peak (pedestal & average drift subtracted)

These figures show ADC value to amount of statistics

Single pixel hit

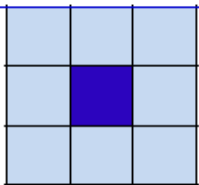

Single isolated pixel hit with ADC value consistent with X ray from Fe55.

We selected single pixel hit event .
CTI can be measured by comparing peak positions of x-ray from Fe55 .

- if CCD can transfer charge signal all, charge transfer efficiency is 1 ...

Characteristics of FPCCD

ii) **Hot pixels**: pixels emitting large dark current.

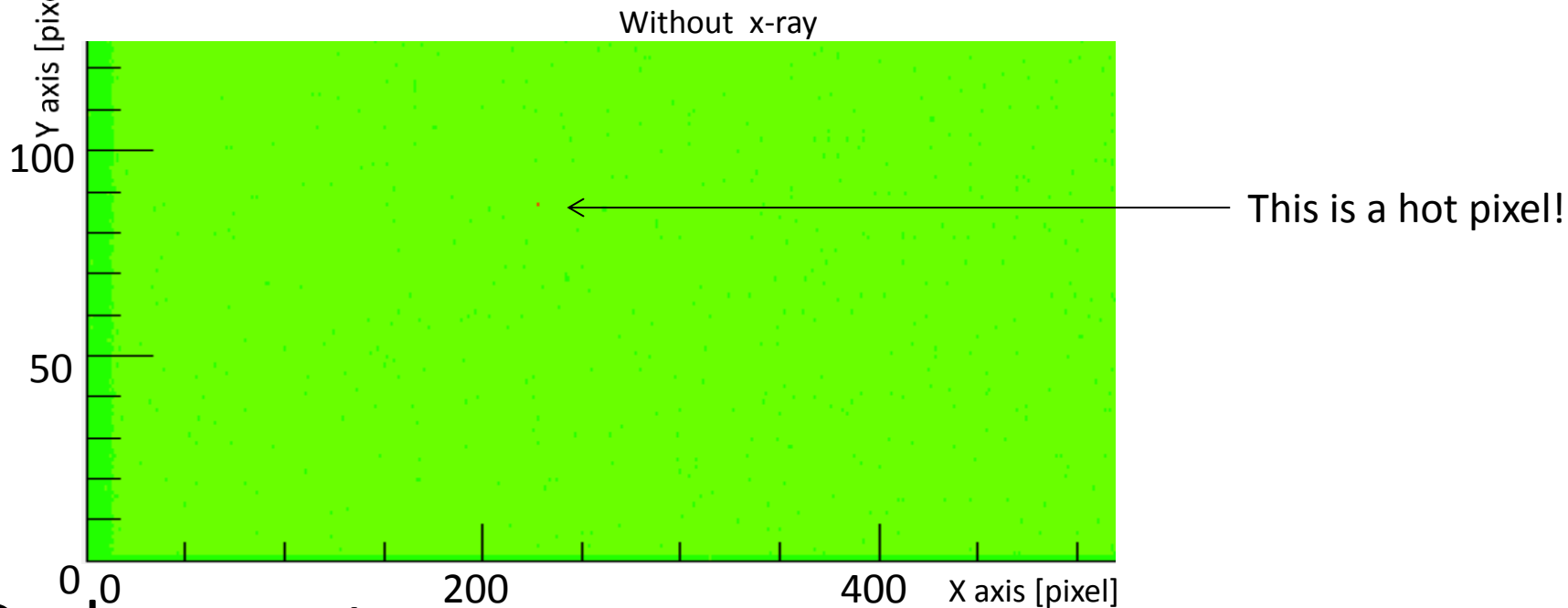

iii) **Dark current**: average of signal without x-ray.

At this irradiation test, we measured these 3 characteristics

Read out modules

Stream of signal is ...

CCD --> ASIC--> FPGA --> SiTCP --> PC

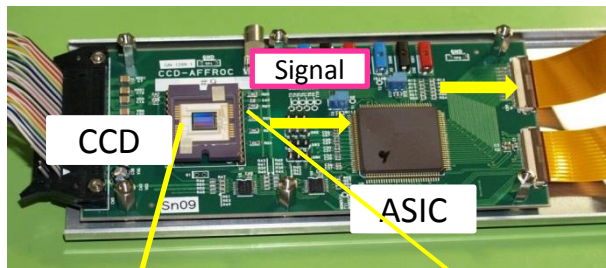

ASIC out put signal

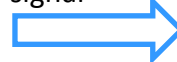

ASIC drive signal

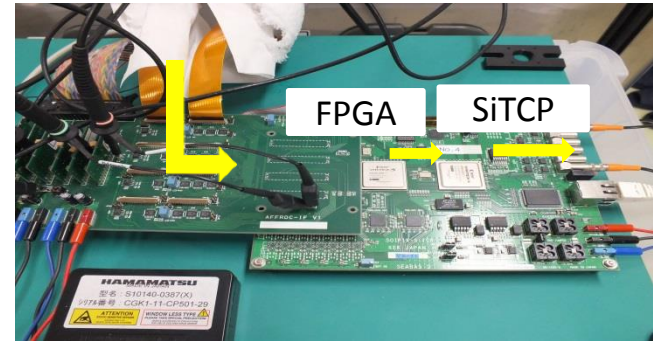

Ethernet connection



CCD spec

Sensitive thickness : $15 \mu m$

Pixel size : CCD has 4 read-out channels. Pixel sizes are ...

$6 \times 6 \mu m^2$, $8 \times 8 \mu m^2$, $9.6 \times 9.6 \mu m^2$, $12 \times 12 \mu m^2$

We only measured $8 \times 8 \mu m^2$, $12 \times 12 \mu m^2$

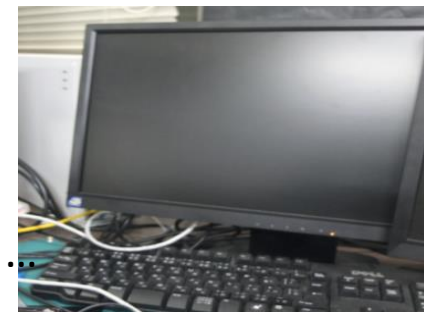

PC

Read-out modules

To test temperature dependence of CTI, dark current, hot pixels, CCD and read out circuit were put into thermal box

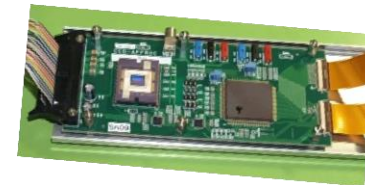
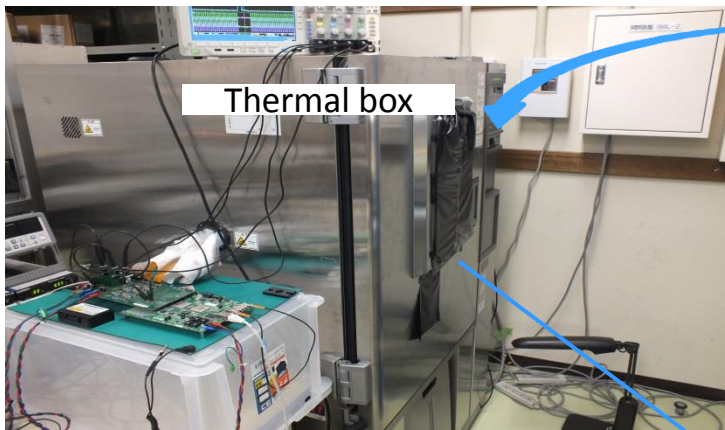

Before irradiation, we measured at
 -40°C , -20°C , 0°C , $+20^{\circ}\text{C}$
 After irradiation, we measured at
 -40°C , -30°C , -20°C , -10°C , 0°C , $+10^{\circ}\text{C}$, $+20^{\circ}\text{C}$

At each temperature, dark frame run and signal run are taken with Fe55 by turning on/off the shutter

shutter	open	close	close	close	close	close
Read out cycle(sec)	10	10	20	30	40	60

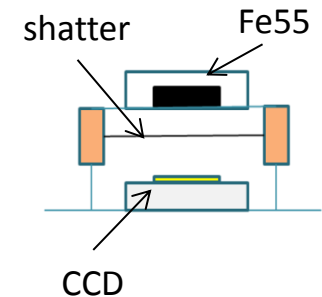
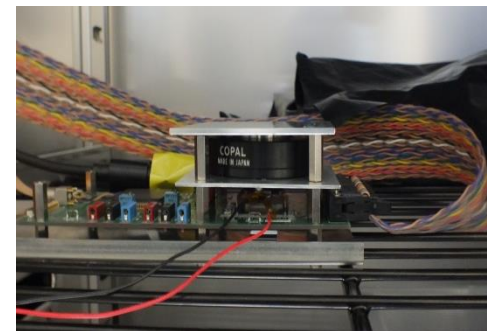

Characteristics before irradiation

i) CTI

I measured CTI of a channel of $12\mu\text{m}$ (512 x 128) pixels at -40°C

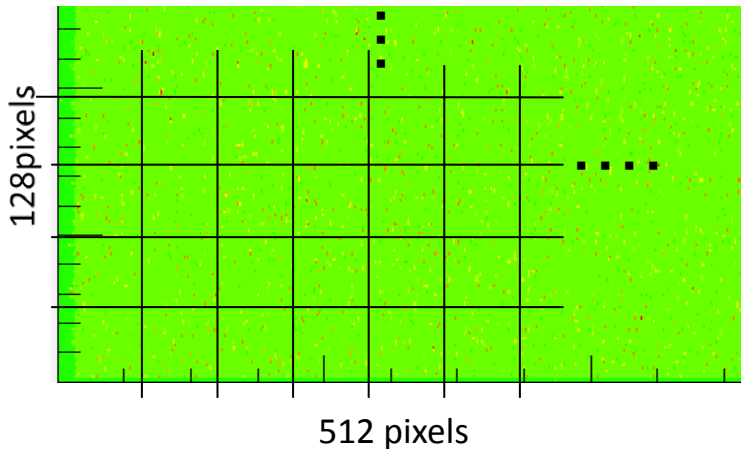

I divided 1 channel to 31×8 regions

1 region has 16×16 pixels

- measured ADC values for each region and fitted to extract CTI.

I fitted this histogram with function

$$\text{Function} = [p0] \times [P1]^x \times [p2]^y$$

[p0] : constant number

[p1] : Horizontal CTE (x direction)

[p2] : Vertical CTE (y direction)

x : region number (x direction)

y : region number (y direction)

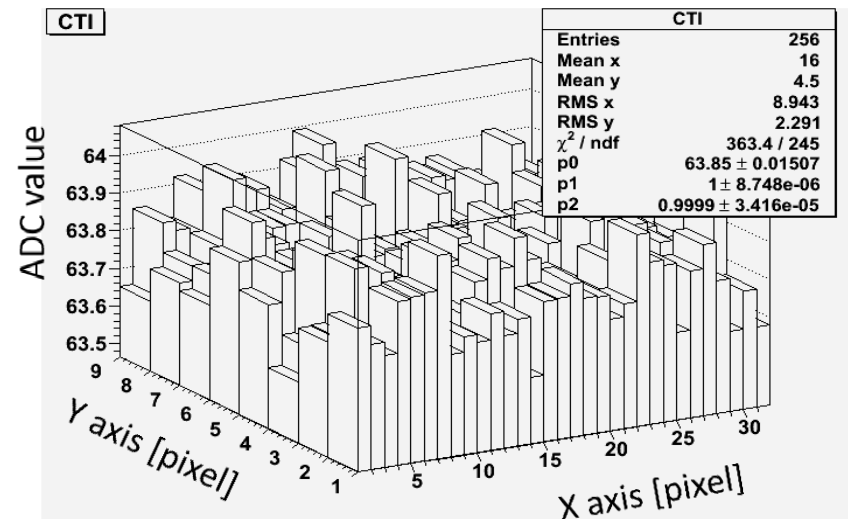

Characteristics before irradiation

ii) Hot pixels

Hot pixels increase depending on temperature. These figures show temperature dependence of hot pixel for 12 μ m pixels channels

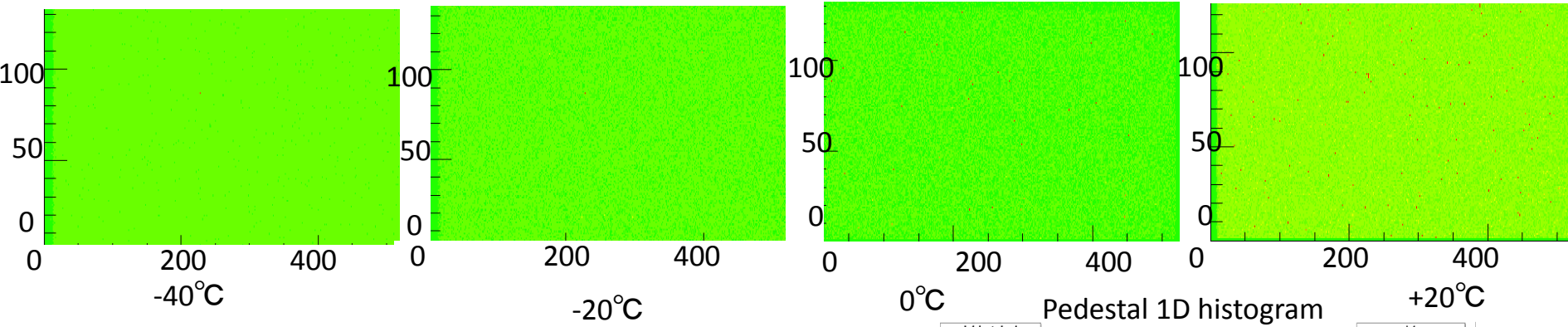

I set threshold level at ADC value of 40 and signals larger than threshold. I considered these are hot pixels.

Cut at 40 level

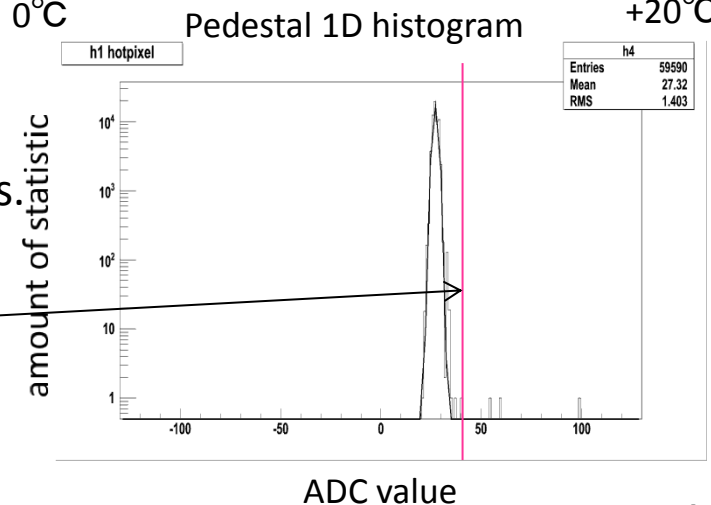

Characteristics before irradiation

Data were taken for 10sec by 10 frames for hot pixel measurements.

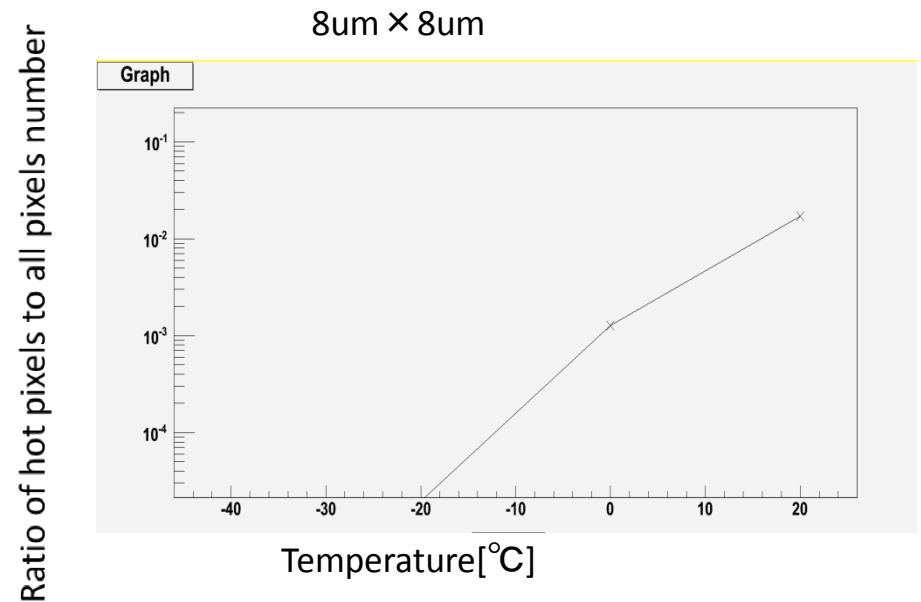
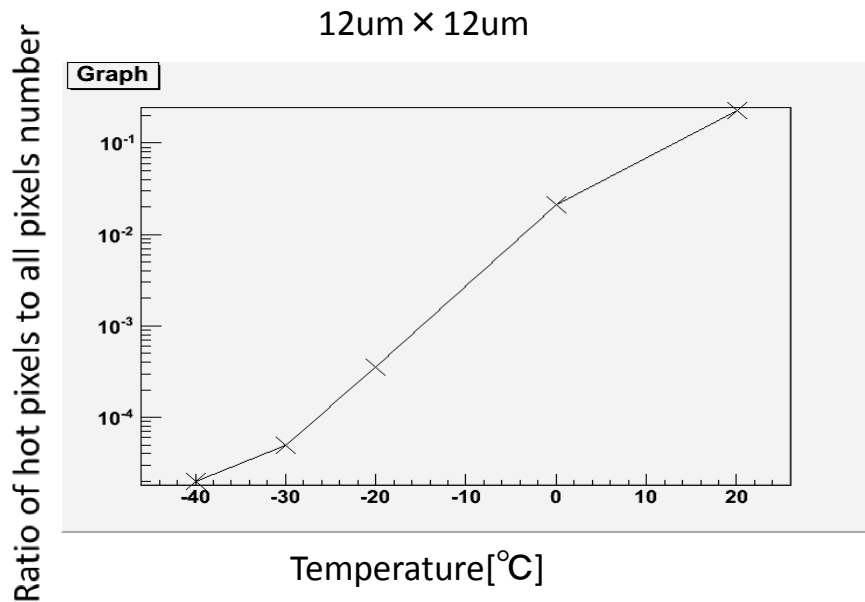

Fraction of hot pixels got larger as the temperature was raised.

- at -40°C, fraction of hot pixels $\cong 0$

Characteristics before irradiation

iii) Dark current

Dark current is proportional to read out time.

We measured dark current 10sec, 20sec, 30sec, 40sec, 60sec.

ADC peak to time(sec) 12um x 12um

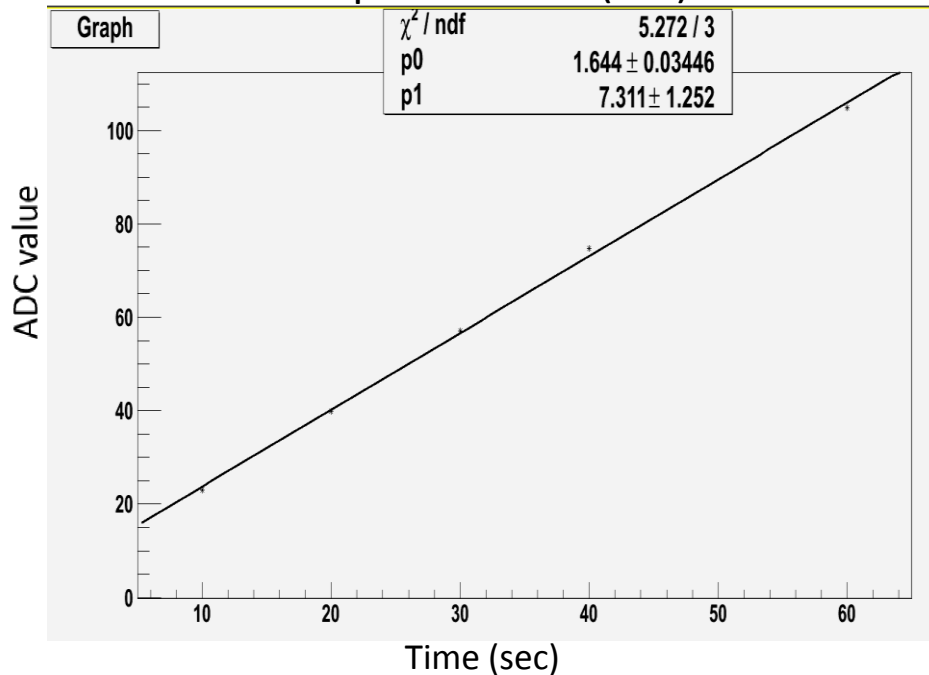

Fit with linear function

$$f = ax+b$$

Then we can derive pedestal level per 1 sec

- gradient means pedestal level per 1 sec

Neutron Irradiation

- Set up

We did neutron beam irradiation at 16,17 Oct at Tohoku University CYRIC. We made neutron beam by irradiating $1\mu\text{A}$ proton beam to 7-8mm thickness Li target.

Irradiated time was

30 minutes 19 sec.

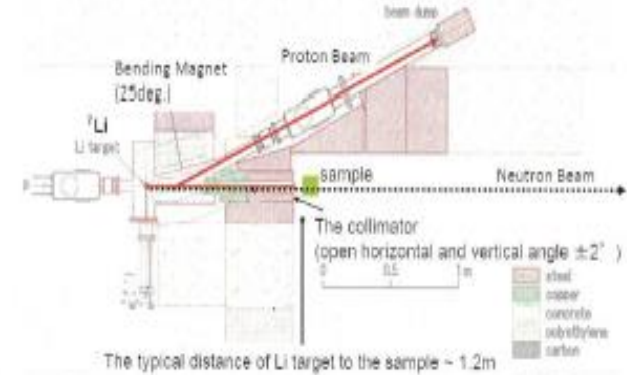

Plastic scintillator

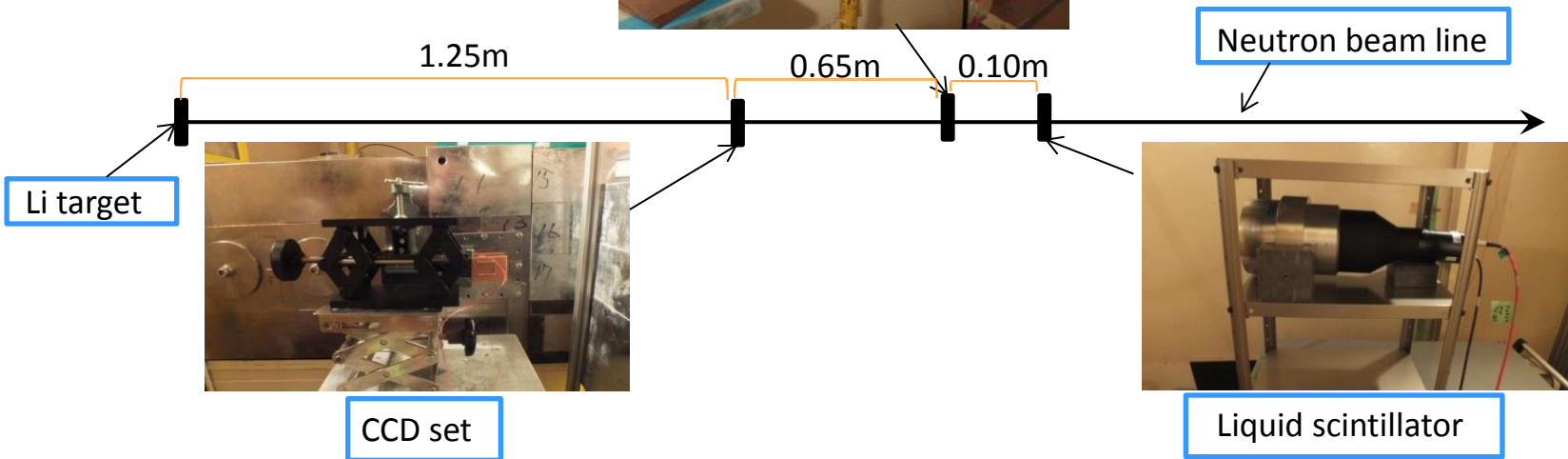

Liquid scintillator

Neutron Irradiation

- Flux of neutron

To measure flux of neutron, we used plastic scintillator and liquid scintillator

- i) First, we used liquid scintillator to measure total number of neutrons after collimator.

$$8.3 \times 10^6 \text{neutron/sec}$$

- ii) Second, we measured beam size by plastic scintillator. And measured beam size at 6 point each 5cm from beam line.

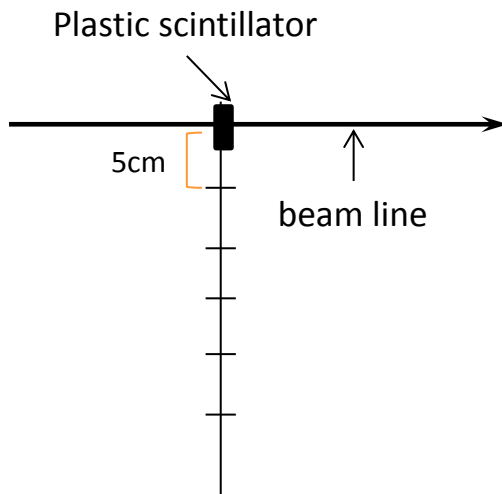

- beam size was **14.7cm** at 1.9m from Li target

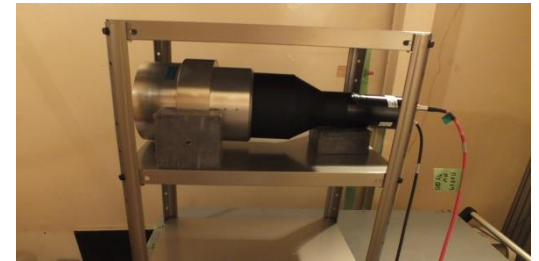

We assumed neutron flux reduces linearly with respect to the distance from beam line

CCD set at 1.25m from Li target was irradiated **9.4×10^8 neutron**

Result

- Hot pixels

After irradiation, we saw many hot pixels.

Before irradiation

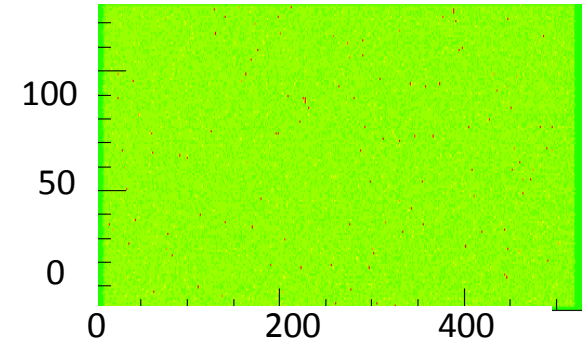
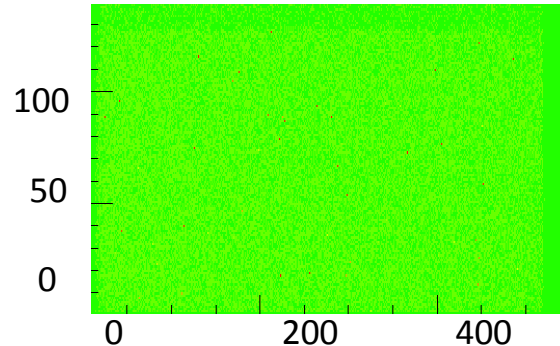
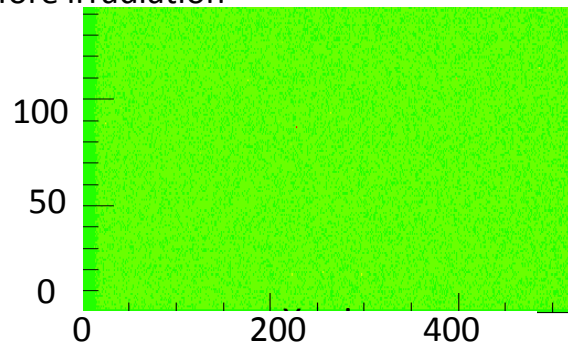

After irradiation (less than one hour after irradiation)

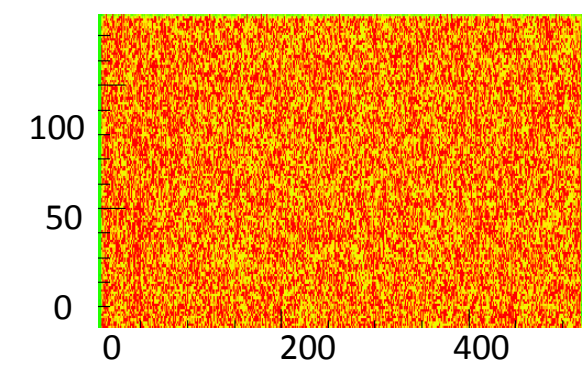
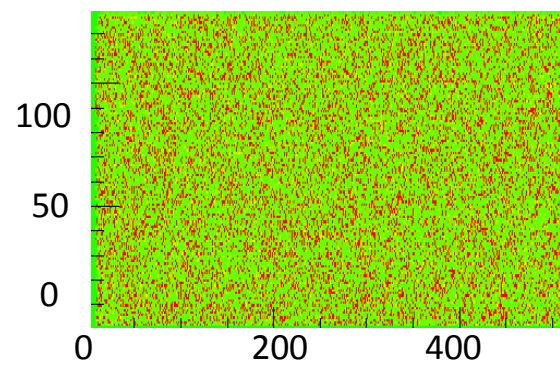
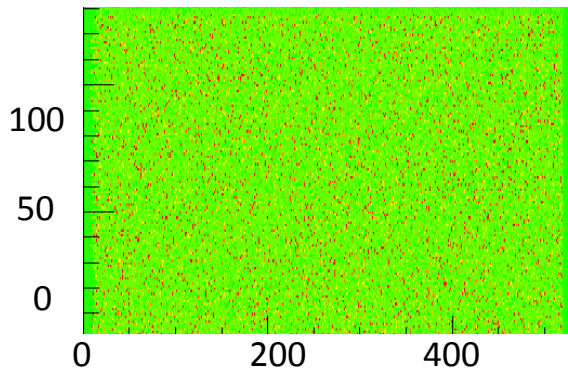

-20°C

0°C

+20°C

Result

12um × 12um

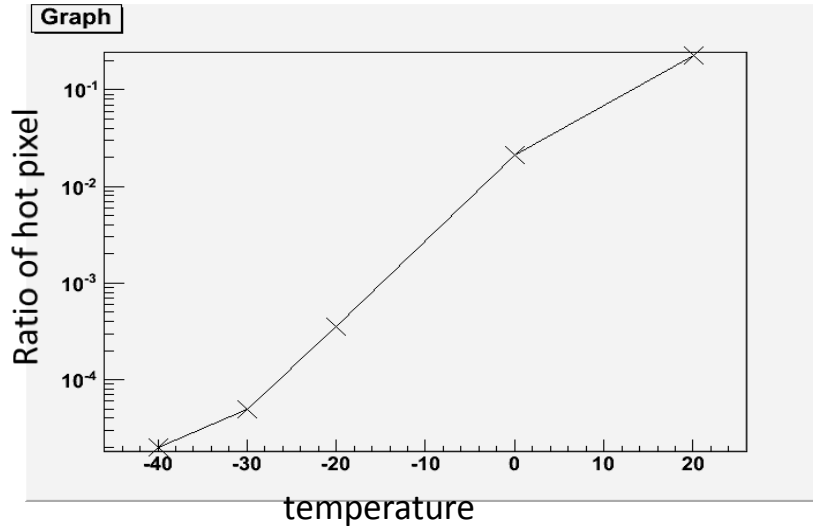

8um × 8um

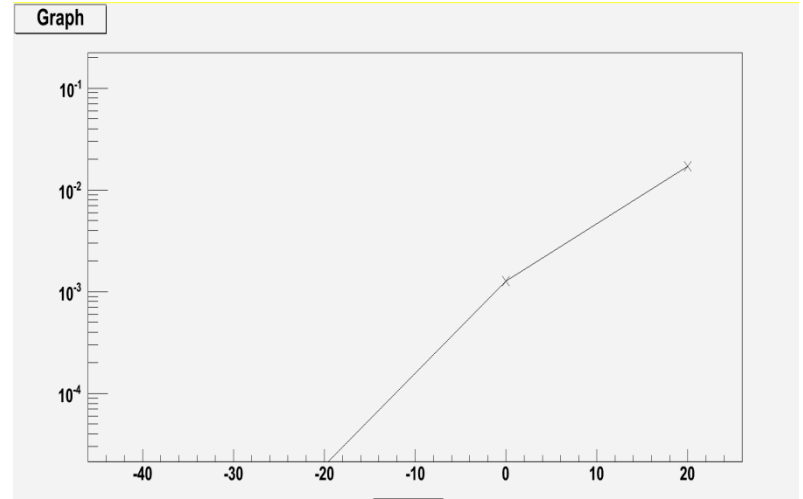

After Irradiation test

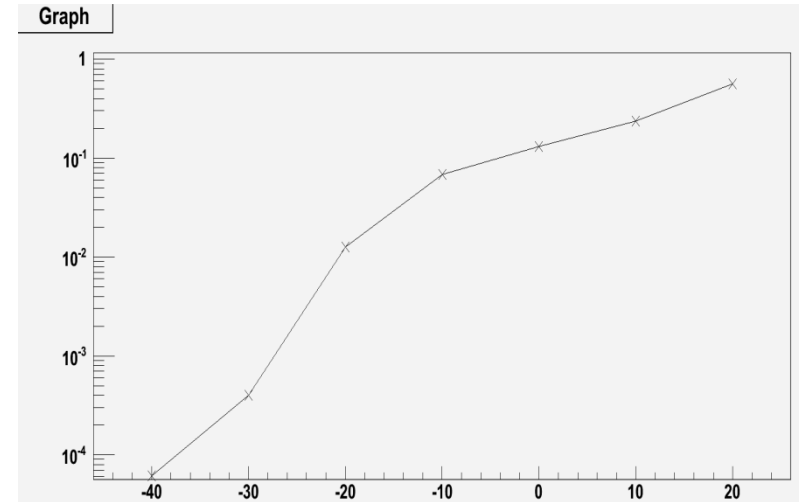
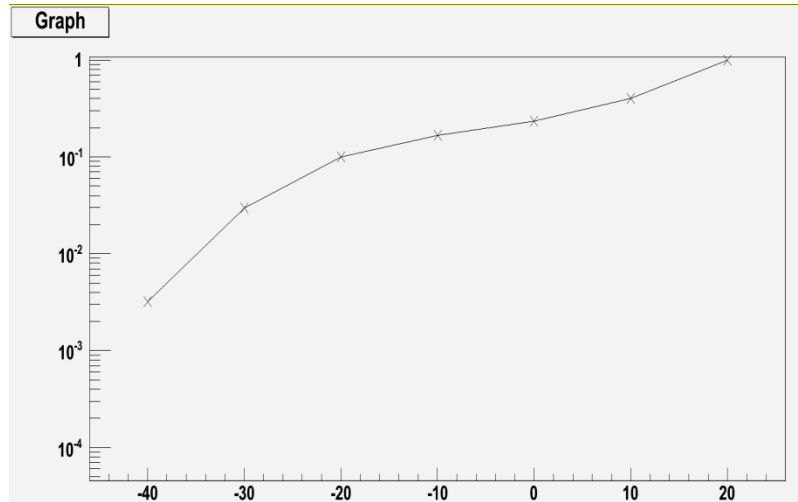

Result

- CTI

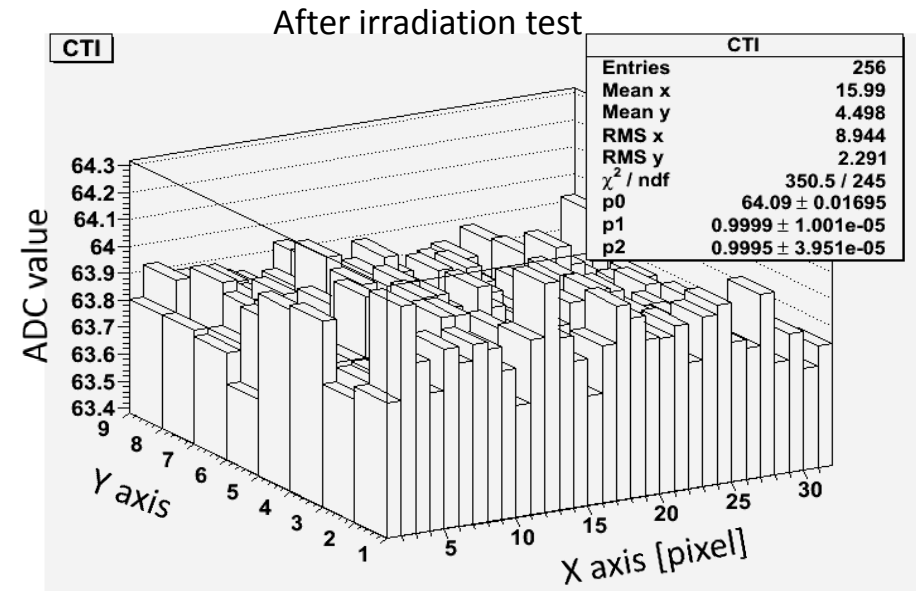
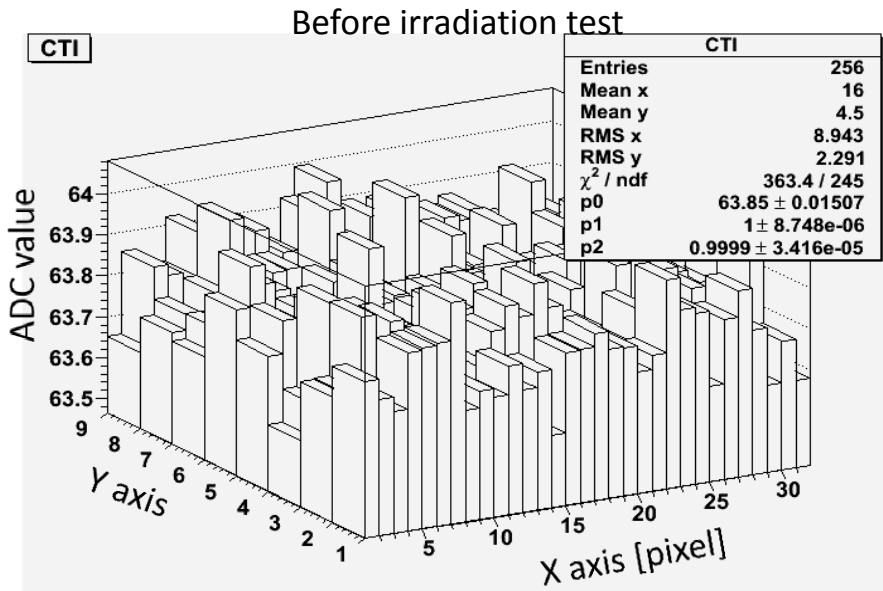

CTI / pixel was ...

X direction : $(1.844 \pm 0.547) \times 10^{-6}$

Y direction : $(4.660 \pm 2.135) \times 10^{-6}$

X direction : $(6.392 \pm 0.626) \times 10^{-6}$

Y direction : $(2.834 \pm 0.247) \times 10^{-5}$

Summary & Plan

- FPCCD is one of the candidate of vertex detector.
- We performed neutron irradiation and measured CTI, dark current and hot pixels.
- After irradiation test, we saw many hot pixels.

Plans

- To measure CTI and dark current at various temperatures.
- To measure dependence of CTI on various parameters such as clock frequency and voltage.

Back Up

